	<p>HySense® QT 3xx</p> <p>Präziser Turbinen-Durchflusssensor mit 2"-SAE Flanschanschluss.</p> <ul style="list-style-type: none"> • Automatische Sensorerkennung ISDS • Geringer Durchflusswiderstand • Ausgangssignal: Frequenz, Analog 4...20mA, CAN 	<p><i>Precise measuring turbine with 2"-SAE flange connection.</i></p> <ul style="list-style-type: none"> • <i>Automatic sensor detection ISDS</i> • <i>Low flow resistance</i> • <i>Output signal: frequency, analog 4...20mA, CAN</i>
<p>Beschreibung <i>Description</i></p>	<p>HySense QT 3xx ist ein hoch präziser Turbinen-Durchflusssensor zum Messen von Volumenstrom in stationären sowie mobilen Hydraulikanlagen. Speziell für die Druck- und Temperaturmessung sind zwei MINIMESS®-Testpunkte in dem Sensor vorinstalliert, sodass Druck sowie Temperatursensoren ohne Anlagenstillstand eingebaut und betrieben werden können. Die ISDS-Funktionalität realisiert eine automatische Sensorerkennung sowie Parametrisierung in Hydrotechnik Messgeräten. Zwei Ausführungen mit Aluminium- oder Edelstahl-Internenteilen sind verfügbar.</p>	<p><i>The HySense QT 3xx is a high precision turbine flow meter which measures volumetric flow rate in stationary and mobile hydraulic equipment's. Two MINIMESS®-test points are specially preassembled to allow both pressure and temperature sensors to be installed without shutting the equipment down. The ISDS-functionality realizes an automatic sensor identification and parameterization in hydrotechnical instruments. Two versions with aluminum or stainless steel internal parts are available.</i></p>
<p>Funktionsprinzip <i>Operating principle</i></p>	<p>Das Turbinenlaufrad wird durch die Strömungsenergie des durchströmenden Mediums in Rotation versetzt. Dabei ist die Laufradfrequenz annähernd proportional zur mittleren Strömungsgeschwindigkeit (über dem Rohrquerschnitt). Resultierend daraus ist der Volumenstrom ebenfalls annähernd proportional zur Laufradfrequenz. Diese wird durch einen externen Sensor detektiert, verarbeitet und ausgegeben.</p>	<p><i>The turbine wheel is set in rotation by the flow energy of the medium. The turbine frequency is approximately proportional to the flow velocities, resulting that the flow rate is also approximately proportional to the turbine frequency. This frequency is detected, processed and delivered by the pickup.</i></p>
<p>Verwendungszweck <i>Designated use</i></p>	<ul style="list-style-type: none"> • Stationäre und mobile Durchflussmessung • Überprüfung von Pumpeneinheiten • Durchflusseinstellung für Anbaugeräte in der Mobilhydraulik • Condition Monitoring von Heiz- und Kühlkreisläufen • Schmiermittelüberwachung in Fertigungsanlagen • Anlagen mit dynamischen & bidirektionalen Durchflüssen • Diagnoseaufgaben 	<ul style="list-style-type: none"> • <i>Stationary and mobile flow measurement</i> • <i>Inspection of pump units</i> • <i>Flow rate adjustment for mobile hydraulic attachments</i> • <i>Condition monitoring of heating and cooling circuits</i> • <i>Lubricant monitoring in production plants</i> • <i>Systems with dynamic & bidirectional flows</i> • <i>Diagnostic tasks</i>

Gebrauchshinweise Note for use	<ul style="list-style-type: none"> • Jegliche Anwendung außerhalb der technischen Spezifikationen sind nicht zulässig • Nicht mit Luft oder Gasen verwenden • Es dürfen sich keine Luftblasen im Hydrauliksystem befinden • Druckschläge vermeiden • Schnellen Richtungswechsel des Messmediums vermeiden • Nicht mit Pressluft ausblasen • Am Turbinenausgang muss der relative Systemdruck ≥ 1 bar sein • Viskositätsabweichung von der Kalibrierviskosität verschlechtert die Messgenauigkeit deutlich 	<ul style="list-style-type: none"> • <i>Any application out of the technical specification aren't allowed</i> • <i>Do not use with air or gas</i> • <i>No air bubbles in the hydraulic system</i> • <i>Avoid pressure shocks</i> • <i>Avoid rapid changes in direction of the medium</i> • <i>Don't clean with compressed air</i> • <i>The relative system pressure must be ≥ 14.5 psi in the turbineflow meter output</i> • <i>Viscosity deviation from the calibration viscosity reduce the measurement accuracy significantly</i>
Hinweise zur Produktauswahl Note for product choice	<p>Für einen sicheren und störungsfreien Betrieb der Volumensensoren ist die richtige Auswahl von Typ und Baugröße entscheidend. Aufgrund verschiedener Anwendungen und Sensorausführungen sind die technischen Daten im Datenblatt allgemeiner Art. Bestimmte Eigenschaften der Geräte sind abhängig von Typ, Baugröße und Messbereich sowie vom Messmedium. Für eine exakte Auswahl setzen sie sich bitte mit Ihrem Kundenberater in Verbindung.</p>	<p><i>For a safe and trouble-free operation of the turbine flow meter is the correct selection of type and size fundamental. The technical data sheet is given in general nature. Certain properties of the devices depend on type, size and range, as well as of the measured liquid. For an accurate selection, please contact your customer consultant</i></p>
Hinweis zum Datenblatt Notes to data sheet	<p>Teil 1 dieses Datenblatts enthält Angaben, die für die gesamte Produktreihe HySense QT 3xx zutreffen. Teil 2 listet die für das jeweilige Ausgangssignal gültigen Eigenschaften auf.</p>	<p><i>Part 1 of the data sheet includes common technical data for the complete HySense QT 3xx series. Finally, part 2 lists the parameters for different output signals.</i></p>

Teil 1
Part 1
Allgemeine Angaben zur Produktserie
Common features for the product series

Eigenschaften Properties			
Parameter	Größe <i>Dimensions</i>	Einheit <i>Units</i>	Bemerkung <i>Remarks</i>
Allgemeine Eigenschaften Common properties			
Ansprechzeit <i>Response time</i>	< 0.05	s	
Viskositätsbereich <i>Viscosity range</i>	1...100	cSt mm ² /s	Höhere Viskositäten auf Anfrage <i>Higher viscosities on request</i>
Zulässiger Betriebsdruck max. <i>Operating pressure max.</i>	420 6000	bar <i>psi</i>	P_N
Berstdruck <i>Burst pressure</i>	4x P_N	bar	P_B
Mediumtemperatur <i>Medium temperature</i>	-20...100 -4...185	°C °F	
Umgebungstemperatur <i>Ambient temperature</i>	-20...85 -4...185	°C °F	
Lagertemperatur <i>Storage temperature</i>	-20...85 -4...185	°C °F	
IP-Schutz <i>Protection</i>	IP 67	Gilt für alle Aufnehmer <i>Applies to all Pick-Ups</i>	
Dichtungsmaterial <i>Sealing material</i>	FKM	Andere auf Anfrage <i>Others on request</i>	
Aufnehmergehäuse <i>Sensor housing</i>	Aluminiumlegierung anodisiert Aluminium alloy anodized	EN AW 2007 / DIN 30645	
Turbinengehäuse <i>Turbine housing</i>	Edelstahl passiviert Stainless steel passivated	1.4305 / DIN EN 2516	
Turbinenrad <i>Turbine wheel</i>	Edelstahl passiviert Stainless steel passivated	1.4104 / DIN EN 2516	
Eigenschaften der Aluminiumausführung Properties of the aluminium design			
Standard Kalibrierviskosität <i>Standard calibration viscosity</i>	30	cSt mm ² /s	
Innenteile <i>Internal parts</i>	Aluminiumlegierung anodisiert / Edelstahl passiviert <i>Aluminium alloy anodized / Stainless steel passivated</i>	EN AW 6026LF / DIN 30645 1.4104 / DIN EN 2516	
Medienverträglichkeit <i>Fluid compatibility</i>	Hydrauliköle, Öle auf Mineralölbasis <i>Hydraulic oils, mineral oil based flu- ids</i>	Andere auf Anfrage <i>Others on request</i>	

Eigenschaften der Edelstahlausführung
Properties of the stainless steel design

Standard Kalibrierviskosität <i>Standard calibration viscosity</i>	2.5	cSt mm ² /s	
Innenteile <i>Internal parts</i>	Edelstahllegierung passiviert <i>Stainless steel passivated</i>	1.4104 / 1.4305 DIN EN 2516	
Medienverträglichkeit <i>Fluid compatibility</i>	Hydrauliköle, Öle auf Mineralölbasis, Klarwasser und wasserhaltige Flüssigkeiten (HFA/HFC) <i>Hydraulic oils, mineral oil based fluids, clear water and water containing liquids (HFA/HFC)</i>	Andere auf Anfrage <i>Others on request</i>	

Baugruppen-Zeichnung
Assembly drawing

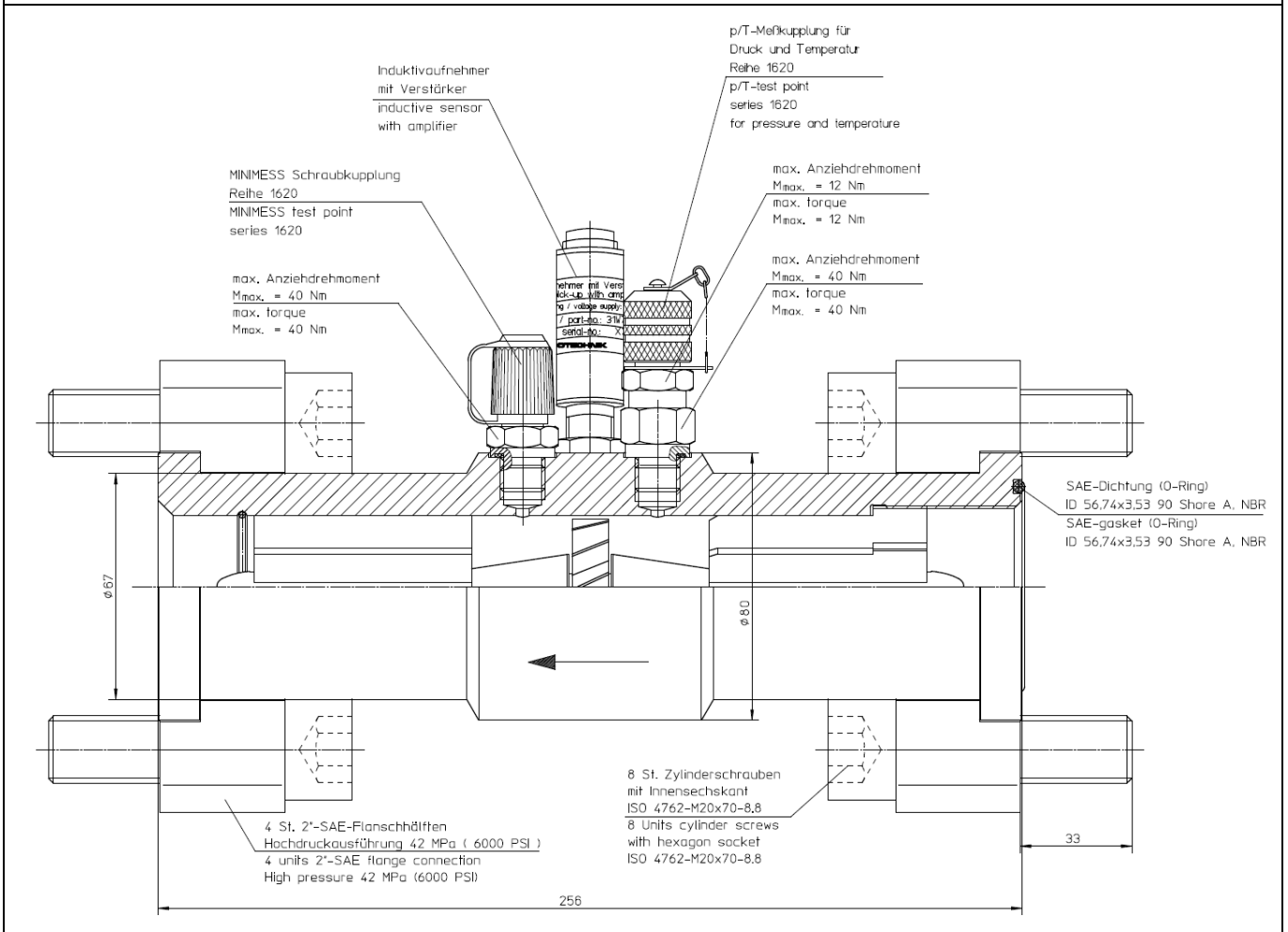

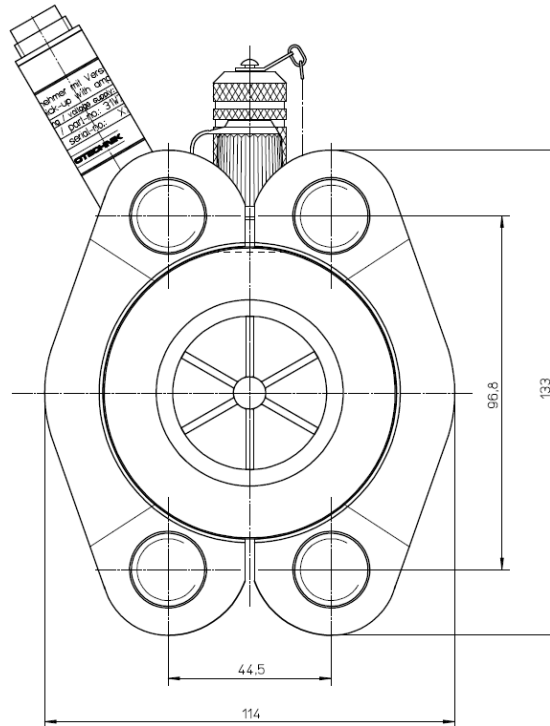
Baugruppen-Zeichnung
Assembly drawing

Baugröße und Eigenschaften
Design size and specifications

Baugröße Design size	Anschlussgewinde Connection size	Rohr Ø Pipe Ø	Länge Length
	[SAE 2"]	[mm]	[mm]
QT 3xx 1000L/min / 270GPM	2"-SAE-Flansch / 2"-SAE-Flange	67	256

Baugröße Design size	Gewicht Weight		Sensorhöhe Sensor height		
	Aluminium	Edelstahl Stainless steel	QT 300	QT 306	QT 310
	[g]	[g]	[mm]	[mm]	[mm]
QT 3xx 1000L/min / 270GPM	5450	5600	62	98	

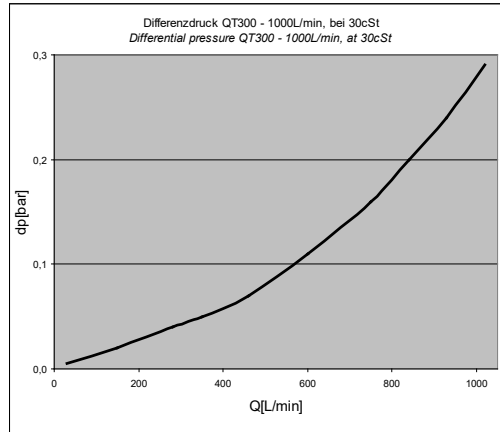
Differenzdruck
Pressure difference



Einbauhinweise
Installation instructions

- | | |
|---|---|
| <ul style="list-style-type: none"> • Einbaulage beliebig, standardmäßige Strömung in Pfeilrichtung • Vor dem Einbau Anlage von Verunreinigungen befreien • Keine Schmutzpartikel >25µm im Messfluid • Nach dem Einbau langsam mit Betriebsmittel füllen und Leitungen entlüften • Starke Querschnittsänderungen in der Einlaufstrecke vermeiden • Empfohlene gerade Einlaufstrecke vor der Messturbine ist 30 x Nenndurchmesser • Empfohlene Auslaufstrecke nach der Turbine 10 x Nenndurchmesser • Keine Faserdichtungen verwenden, Gewindedichtmittel für Anschlussstücke verwenden (z.B. Loctite 577) • Zum Lieferumfang gehören: <ul style="list-style-type: none"> ○ 4 St. SAE-Flanschhälften 2", gerade Ausführung ○ 1 St. SAE-Dichtung ○ 8 St. Zylinderschrauben DIN 912 | <ul style="list-style-type: none"> • Any mounting position possible, standard flow in direction of arrow • Before mounting, clean the system by thoroughly rinsing of contaminants • No particles > 25µm in the fluid • After mounting, please fill slowly with the operating medium and vent the pipes • Avoid strong cross-sectional changes in the inlet zone • Recommended straight inlet zone of the turbine is 30 x nominal diameter • Recommended outlet zone of the turbine is 10 x nominal diameter • Don't use fiber gasket, use thread gasket for fittings (for example Loctite 577) • The package includes: <ul style="list-style-type: none"> ○ 4 Units SAE flange connection 2", straight ○ 1 Unit SAE seal ○ 8 Units cylinder screws DIN 912 |
|---|---|

Anzugsmomente (Toleranz +10%, Edelstahlgewinde schmieren)
 Recommended tightening torque (tolerance +10%, thread lubricated)

MINIMESS® ISO228-G 1/4 Torque MINIMESS® ISO228-G 1/4	40 Nm
MINIMESS® 7/16-20 UNF (ANSI B1.1) Torque MINIMESS® 7/16-20 UNF (ANSI B1.1)	30 Nm
Signalaufnehmer Torque sensor nut	10 Nm

Typenschlüssel für Turbinen Volumendurchflusssensoren QT 3xx
Type code for turbine flow meter QT 3xx
Bestellbeispiel:**How to order:**

3	1	V	F	-	88	-	3	5	.	030	
Messgeräte / Sensorik allgemein / Instruments / Sensors general	Medienverträglichkeit / Medium compatibility	Aufnehmer / sensor	Serie / series	Anschlussgewinde / Durchflussbereich connecting thread / flow range	88	-	Bestückung Pos.1 mounting Pos.1	Bestückung Pos.2 mounting Pos.2	.	Kalibrierviskosität calibration viscosity	
										V012	2.5cSt ¹
										030	30cSt ²
										xxx	xxxxcSt (auf Anfrage)
										5	p/T-Messkupplung Reihe 1620 (Kennzahl 04)
6	p/T-Messkupplung Reihe 1615 (Kennzahl 04)										
2	Schraubkupplung Reihe 1615, Kunststoffkappe										
3	Schraubkupplung Reihe 1620, Kunststoffkappe										
				88	SAE 2" Code 62					45...1000 L/min	
			F	QT 3xx							
		C	QT 306 CAN, elektr. Anschluss M12, 5-pol.								
		J	QT 310 Analog 4...20mA, elektr. Anschluss M16, 6-pol., ISDS								
		V	QT 300 Frequenz, elektr. Anschluss M16, 6-pol., ISDS								
	1	Hydrauliköle und Öle auf Mineralölbasis									
	3	Wasser									
	A	Skydrol (auf Anfrage / on request)									
3											

Typenschild (exemplarisch)**Type plate (example)**

HySense QT 300 Turbinen-Volumenstromsensor / Turbine flow meter 31VF-88-35.030 SN 12345 45...1000 L/min / 11.07...264.17 GPM max. 420 bar, 6092 psi, 42 MPa Limburg / Germany	 	Kalibrierwert Calibration Value [L/min / kHz] @ 30mm/H ₀ → 122.8
---	--	---

¹ Standardkalibrierung Edeldstahlausführung / Standard calibration aluminium design

² Standardkalibrierung Aluminiemausführung / Standard calibration stainless steel design

TKZ Order number	Zubehör und Ersatzteile Accessories and spare parts
8824-S1-xx.xxS ³	Messkabel, Frequenz, 4...20mA, M16 6-pol. Stecker – M16 6-pol. Buchse <i>measuring cable frequency, 4...20mA, M16 6-pole connector – 6-pole M16 socket</i>
8824-S1-xx.xxH ³	Messkabel, Frequenz, 4...20mA, ISDS, M16 6-pol. Stecker – M16 6-pol. Buchse (High End) <i>measuring cable frequency, 4...20mA, M16 6-pole connector – 6-pole M16 socket (High End)</i>
8824-S6-xx.xxS ³	Messkabel, Frequenz, 4...20mA, M16 6-pol. Stecker – offenes Kabelende <i>measuring cable frequency, 4...20mA, M16 6-pole connector – open cable end</i>
8824-S6-xx.xxH ³	Messkabel, Frequenz, 4...20mA, ISDS, M16 6-pol. Stecker – offenes Kabelende (High End) <i>measuring cable frequency, 4...20mA, M16 6-pole connector – open cable end (High End)</i>
8824-S2-xx.xxS ⁴	Adapterkabel, Frequenz, 4...20mA, M16 5-pol. Stecker – M16 6-pol. Buchse <i>adapter cable frequency, 4...20mA, M16 5-pole connector – 6-pole M16 socket</i>
8824-S2-xx.xxH ⁴	Adapterkabel, Frequenz, 4...20mA, ISDS, M16 5-pol. Stecker – M16 6-pol. Buchse (High End) <i>adapter cable frequency, 4...20mA, M16 5-pole connector – 6-pole M16 socket (High End)</i>
8824-S3-xx.xxS ⁵	Verlängerungskabel, Frequenz, 4...20mA, M16 6-pol. Stecker – M16 6-pol. Buchse <i>extension cable frequency, 4...20mA, M16 6-pole connector – 6-pole M16 socket</i>
8824-S3-xx.xxH ⁵	Verlängerungskabel, Frequenz, 4...20mA, M16 6-pol. Stecker – M16 6-pol. Buchse (High End) <i>extension cable frequency, 4...20mA, M16 6-pole connector – 6-pole M16 socket (High End)</i>
8824-N3-xx.xx ⁶	Messkabel CAN, M12 5-pol. Stecker – M12 5-pol. Buchse <i>measuring cable CAN, M12 5-pole connector – M12 5-pole socket</i>
8824-R7-xx.xx ⁶	Messkabel CAN, M12 8-pol. Stecker – M12 5-pol. Buchse <i>measuring cable CAN, M12 8-pole connector – M12 5-pole socket</i>
8824-T6-xx.xx ⁶	Messkabel CAN, M12 8-pol. Stecker – M12 8-pol. Buchse <i>measuring cable CAN, M12 8-pole connector – M12 8-pole socket</i>
8824-L0-xx.xx ⁶	Messkabel CAN, M12 5-pol. Buchse – offenes Kabelende <i>measuring cable CAN, M12 5-pole socket – open cable end</i>
8824-T1-xx.xx ⁶	Messkabel CAN, M12 8-pol. Buchse – offenes Kabelende <i>measuring cable CAN, M12 8-pole socket – open cable end</i>
8824-V1-02.50	Messkabel, Frequenz, 4...20mA, M12 4-pol. Stecker – offenes Kabelende <i>measuring cable frequency, 4...20mA, M12 4-pole connector – open cable end</i>
8824-V3-02.50S	Messkabel, Frequenz, 4...20mA, M16 6-pol. Stecker – M12 4-pol. Buchse (Standard) <i>measuring cable frequency, 4...20mA, M16 6-pole connector – 4-pole M12 socket (Standard)</i>
8824-V3-02.50H	Messkabel, Frequenz, 4...20mA, M16 6-pol. Stecker – M12 4-pol. Buchse (High End) <i>measuring cable frequency, 4...20mA, M16 6-pole connector – 4-pole M12 socket (High End)</i>

³ Verfügbare Standardlängen: 02.50 = 2,5m; 05.00 = 5,0m; 10.00 = 10,0m. *Available standard lengths: 02.50 = 2,5m; 05.00 = 5,0m; 10.00 = 10,0m.*

⁴ Verfügbare Standardlängen: 00.30 = 0,3m; 02.50 = 2,5m; 05.00 = 5,0m; 10.00 = 10,0m. *Available standard lengths: 00.30 = 0,3m; 02.50 = 2,5m; 05.00 = 5,0m; 10.00 = 10,0m.*

⁵ Verfügbare Standardlängen: 10.00 = 10,0m; 20.00 = 20,0m. *Available standard lengths: 10.00 = 10,0m; 20.00 = 20,0m.*

⁶ Verfügbare Standardlängen: 02.50 = 2,5m; 05.00 = 5m. *Available standard lengths: 02.50 = 2,5m; 05.00 = 5m.*

TKZ Order number	Zubehör und Ersatzteile Accessories and spare parts
2149-04-15.53N	p/T MINIMESS®-Testpunkt (FKM), ISO 228 G1/4", Stahl <i>p/T MINIMESS®-test point (FKM), ISO 228 G1/4", steel</i>
2749-04-15.53	p/T MINIMESS®-Testpunkt (FKM), ISO 228 G1/4", Edelstahl <i>p/T MINIMESS®-test point (FKM), ISO 228 G1/4", stainless steel</i>
2103-01-18.10N	p MINIMESS®-Testpunkt (FKM), ISO 228 G1/4", Stahl <i>p MINIMESS®-Testpunkt (FKM), ISO 228 G1/4", steel</i>
2703-01-18.10	p MINIMESS®-Testpunkt (FKM), ISO 228 G1/4", Edelstahl <i>p MINIMESS®-Testpunkt (FKM), ISO 228 G1/4", stainless steel</i>
3410-16P0-A233F03 ⁷	HySense RS 500, Frequenz, M16 6-pol. Stecker <i>HySense RS 500, frequency, M16 6-pol. connector</i>
3410-16P0-A211F07 ⁷	HySense RS 500, Frequenz, M12 4-pol. Stecker <i>HySense RS 500, frequency, M12 4-pol. connector</i>
3410-14P0-A233Z1S ⁷	HySense RS 510, analog 4...20mA, M16 6-pol. Stecker <i>HySense RS 510, analog 4...20mA, M16 6-pol. connector</i>
3410-14P0-A211Z13 ⁷	HySense RS 510, analog 4...20mA, M12 4-pol. Stecker <i>HySense RS 510, analog 4...20mA, M12 4-pol. connector</i>
3410-14P0-A213C11 ⁷	HySense RS 506, CAN, M12 5-pol. Stecker <i>HySense RS 506, CAN, M12 5-pol. connector</i>

Rekalibrierung von Volumendurchflusssensoren *Recalibration from flow sensors*

Jeder Volumendurchflusssensor besitzt eine individuelle Messcharakteristik, welche selbst bei gleichen Sensortypen sowie -größen variiert. Grund hierfür sind die mechanischen Fertigungstoleranzen, die massiven Einfluss auf die Messcharakteristik haben. Resultierend daraus muss jeder neue Sensor kalibriert und justiert werden, um eine spezifizierte Messperformance sicherzustellen. Wird ein Sensor im Feld betrieben, erfolgt in Abhängigkeit der Betriebsart und der Betriebsbedingungen eine zeitliche Änderung der Messcharakteristik. Diese Veränderung resultiert aus Überlastbetrieb, Ablagerungen, Kontaminierung, Alterung sowie Änderung der Medieneigenschaften. Die Veränderung der Messcharakteristik kann sich negativ auf die Messperformance auswirken. Dies kann nicht im Vorfeld prognostiziert werden und ist vom jeweiligen Einsatzfall abhängig. Infolgedessen sollte jeder Sensor in bestimmten Intervallen recalibriert werden, um diese Veränderung festzustellen und ggf. zu kompensieren. Wir empfehlen folgende Kalibrierintervalle, falls keine Erfahrungswerte vorliegen.

Each volume flow sensor has an individual measuring characteristic which varies even with the same sensor types and sizes. The reason for this is the mechanical manufacturing tolerances, which have a massive influence on the measurement characteristics. As a result, each new sensor must be calibrated and adjusted to ensure a specified measurement performance. When a sensor is operated in the field, the measurement characteristics change over time depending on the operating mode and operating conditions. This change results from overload operation, deposits, contamination, ageing and changes in media properties. The change in the measurement characteristic can have a negative effect on the measurement performance. This cannot be predicted in advance and depends on the specific application. Consequently, each sensor should be recalibrated at certain intervals to detect and, if necessary, compensate for this change. We recommend the following calibration intervals, if no empirical data are available.

⁷ Bei der Bestellung dieses Teiles wird die Seriennummer des alten Aufnehmers oder des zugehörigen Volumenstromsensor benötigt.
The serial number of the old transducer or the associated volumetric flow sensor is required when you ordering this part.

Rekalibrierung von Volumendurchflusssensoren
Recalibration from flow sensors

- | | |
|---|---|
| <ul style="list-style-type: none"> • Laboreinsatz (temp. Einsatz als Mastergeber mit geringer Einsatzdauer)
→ 36 Monate • Standardgebrauch (temp. Einsatz bei Teillast)
→ 24 Monate • Erhöhte Belastung (station. Einsatz bei Teillast)
→ 12 Monate • Extreme Belastung (station. Einsatz bei Vollast)
→ 6 Monate | <ul style="list-style-type: none"> • <i>Laboratory application (temporary use as a master encoder with a short operating time)</i>
→ 36 months • <i>Standard use (temporary use with partial load)</i>
→ 24 months • <i>Increased load (stationary use with partial load)</i>
→ 12 months • <i>Extreme load (steady load at full load)</i>
→ 6 months |
|---|---|

Umrechnung, Durchfluss ↔ Strom
Conversion, flow rate ↔ current

Durchfluss → Strom <i>flow rate → current</i>	Strom → Durchfluss <i>current → flow rate</i>
$I(Q_{\text{read}}) = \frac{16 \text{ mA} \cdot Q_{\text{read}}}{Q_{\text{max}}} + 4 \text{ mA}$	$Q(I_{\text{read}}) = \frac{Q_{\text{max}} \cdot (I_{\text{read}} - 4 \text{ mA})}{16 \text{ mA}}$

Europäische Konformität
European Conformity

Elektromagnetische Verträglichkeit / <i>electromagnetic compatibility</i>	Richtlinie 2004/108/EG	Directive 2004/108/EG
Druckgeräte / <i>pressure equipment</i>	Richtlinie 2014/68/EU	Directive 2014/68/EU
Beschränkung gefährlicher Stoffe / <i>Restriction of Hazardous Substances Directive</i>	Richtlinie 2011/65/EU	Directive 2011/65/EU

REACH-Regulation (EU)
No.1907/2006, Art. 33

Die HYDROTECHNIK GmbH ist als Hersteller von Erzeugnissen, im Sinne der REACH-Verordnung, nachgeschalteter Anwender geringer Mengen und somit nicht registrierungspflichtig. Gemäß Artikel 33 der REACH-Verordnung informieren wir Sie hiermit, dass von uns gelieferte Produkte aus Automatenstahl bis zu 0,35% Massenprozent Blei enthalten können. Außer diesem beinhalten unsere Produkte keine weiteren Stoffe der derzeitigen REACH-Kandidatenliste (SVHC).

HYDROTECHNIK GmbH as a manufacturer of products is, with regard to the REACH regulation, a downstream-user of small quantities. As such it is not obliged to register. In accordance with Article 33 of the REACH Regulation, we hereby inform you that products made of free cutting steel supplied by us can contain up to 0.35% percent by weight lead. Apart from this, our products do not contain other substances from the current REACH Candidate List (SVHC).

Haftungsausschuss
Limitation of Liability

Die genannten technischen Daten werden unter Laborbedingungen ermittelt. Hierbei werden die aktuell gültigen Normen zugrunde gelegt, sofern zutreffend. Für nicht durch

The technical data listed were determined under laboratory conditions. Test criteria were defined in accordance to currently valid norms, as far as available. For properties, which

	<p>Normierung definierte Eigenschaften werden in Anlehnung an Normen für verwandte Produkte eigene Testkriterien definiert. Nur insoweit werden Eigenschaften zugesichert.</p> <p>Die Produkte dürfen nur ihrer Bestimmung gemäß verwendet werden. Die Prüfung der Eignung für den vom Auftraggeber vorgesehenen Verwendungszweck bzw. den Einsatz unter Gebrauchsbedingungen, obliegt dem Auftraggeber; hierfür übernimmt die HYDROTECHNIK GmbH keine Gewährleistung.</p> <p>Änderungen an Produkten und Dokumentationen im Sinne des technischen Fortschritts und der stetigen Verbesserung sind vorbehalten und können jederzeit ohne vorherige Mitteilung eintreten. Die dann gültigen Spezifikationen können von den Angaben in dieser Revision des technischen Datenblatts abweichen. Druckfehler sind vorbehalten. Im Zweifelsfall gilt die deutsche Sprachversion.</p>	<p><i>are not defined in any norm for the given product, test criteria are based on norms for similar products. Any liability is limited accordingly.</i></p> <p><i>All of the devices and components listed may be used for their intended purpose only. It remains to the customer's responsibility to qualify whether the device is suitable for the customer's intended purpose and the intended conditions of use or not; we do not assume any liability in this respect.</i></p> <p><i>Changes of products and documentation in the sense of technical progress and continuous improvement may occur at any time without prior notification. Hence specifications may then differ from those given in this revision of the technical data sheet.</i></p> <p><i>There is no liability for possible misprints.</i></p> <p><i>The German language version is valid in any case of doubt.</i></p>
--	--	---

Teil 2
Part 2
Eigenschaften nach Ausgangssignal
Parameters for output signal
Frequenz

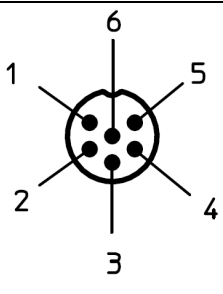
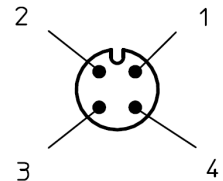
Pinbelegungen <i>Pin assignments</i>	Bezeichnung <i>Labeling</i>	Nr. <i>No</i>	Funktion	<i>Function</i>
Rundsteckverbinder M16 x 0.75 mit Schraubverriegelung, Ausführung 06-a, 6-polig, Stecker <i>Circular connectors M16 x 0.75 with screw-locking Layout 06-a, 6 poles, male IEC / DIN EN 61076-2-106</i>				
 <p>M16 6p</p>	QT 300 Frequenz / Frequency			
	f-Signal	1	Frequenzsignal	<i>Frequency signal</i>
	GND	2	Masse	<i>Ground</i>
	+Ub	3	Versorgungsspannung	<i>Supply voltage</i>
	NC	4	nicht verbunden	<i>not connected</i>
	NC	5	nicht verbunden	<i>not connected</i>
ISDS	6	Sensorerkennung	<i>Sensor detection</i>	
Rundsteckverbinder M12 x 1 mit Schraubverriegelung A-Kodierung, 4-polig, Stecker IEC / DIN EN 61076-2-101 <i>Circular connectors M12 x 1 with screw-locking A-coding, 4 poles, male IEC / DIN EN 61076-2-101</i>				
 <p>M12 4p</p>	QT 300 Frequenz / Frequency			
	+Ub	1	Versorgungsspannung	<i>Supply voltage</i>
	ISDS	2	Sensorerkennung	<i>Sensor detection</i>
	GND	3	Masse	<i>Ground</i>
f-Signal	4	Frequenzsignal	<i>Frequency signal</i>	

Messgenauigkeit mit ISDS oder Linearisierung
Accuracy with ISDS or linearisation

Kalibrierter Bereich <i>Calibrated range</i>				Messgenauigkeit <i>Accuracy</i>
L/min		GPM		%
45	1000	12	270	± 0.5 vom Messwert / <i>of reading</i>

Messgenauigkeit ohne Linearisierung
Accuracy without linearisation

Kalibrierter Bereich <i>Calibrated range</i>				Messgenauigkeit <i>Accuracy</i>
L/min		GPM		%
45	1000	12	270	± 2.5 vom Messwert / <i>of reading</i>

CAN

Pinbelegungen <i>Pin assignments</i>	Bezeichnung <i>Labeling</i>	Nr. <i>No</i>	Funktion	Function
Rundsteckverbinder M12 x 1 mit Schraubverriegelung A-Kodierung, 5-polig, Stecker IEC / DIN EN 61076-2-101 <i>Circular connectors M12 x 1 with screw-locking A-coding, 5 poles, male IEC / DIN EN 61076-2-101</i>				
	QT 306 CAN			
	CAN SHLD	1	CAN Schirm	<i>CAN Shield</i>
	CAN V+	2	CAN Versorgung	<i>CAN Supply</i>
	CAN GND	3	CAN Masse	<i>CAN Ground</i>
	CAN H	4	CAN High	<i>CAN High</i>
	CAN L	5	CAN Low	<i>CAN Low</i>

Messgenauigkeit <i>Accuracy</i>				
Kalibrierter Bereich <i>Calibrated range</i>				Messgenauigkeit <i>Accuracy</i>
L/min		GPM		%
45	1000	12	270	± 0.5 vom Messwert / <i>of reading</i>

CANopen Parameter					
Übertragungsrate / <i>transfer rate</i>	20		1000	kBit/s	
PDO / <i>process data object</i>		1			
Knoten Nr. / <i>Node Id.</i>		10			(hex = 0x0A)
COB ID PDO1		394			(hex = 0x18A)
Senderate / <i>sending rate</i>	10		1000	ms	
Geräte Status / <i>node state</i>		pre-operational			
Prozessdaten: <i>process data</i>					
Frequenz / <i>frequency</i>		fx1000		Hz	
Signaltyp / <i>value type</i>		ulong		Bytes	Byte [0...3]
Beispiel / <i>example</i>					1kHz => 0x000F4240
Volumenstrom / <i>flow rate</i>		Qx1000		l/min	alternativ gal / min
Signaltyp / <i>value type</i>		ulong		Bytes	Byte [4...7]
Beispiel / <i>example</i>					200l/min => 0x00030D40

Analog 4...20mA

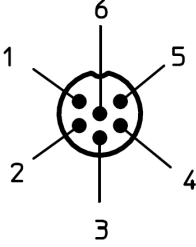
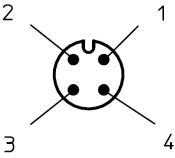
Pinbelegungen <i>Pin assignments</i>	Bezeichnung <i>Labeling</i>	Nr. <i>No</i>	Funktion	Function
Rundsteckverbinder M16 x 0.75 mit Schraubverriegelung, Ausführung 06-a, 6-polig, Stecker <i>Circular connectors M16 x 0.75 with screw-locking Layout 06-a, 6 poles, male IEC / DIN EN 61076-2-106</i>				
 <p>M16 6p</p>	QT 310 4...20 mA 2-Draht / 2-wire			
	Signal	1	Signal	Signal
	ISDS GND ⁸	2	Masse	Ground
	+Ub	3	Versorgungsspannung	Supply voltage
	NC	4	nicht verbunden	not connected
	NC	5	nicht verbunden	not connected
	ISDS	6	Sensorerkennung	Sensor detection
Rundsteckverbinder M12 x 1 mit Schraubverriegelung A-Kodierung, 4-polig, Stecker IEC / DIN EN 61076-2-101 <i>Circular connectors M12 x 1 with screw-locking A-coding, 4 poles, male IEC / DIN EN 61076-2-101</i>				
 <p>M12 4p</p>	QT 310 4...20 mA 2-Draht / 2-wire			
	+Ub	1	Versorgungsspannung	Supply voltage
	ISDS	2	Sensorerkennung	Sensor detection
	Signal	3	Signal	Signal
ISDS GND ⁸	4	Masse	Ground	

Messgenauigkeit <i>Accuracy</i>				
Kalibrierter Bereich <i>Calibrated range</i>				Messgenauigkeit <i>Accuracy</i>
L/min		GPM		%
45	1000	12	270	± 0.5 vom Messwert / of reading zzgl. / plus ±0.1 vom Endwert / of full scale

⁸ Der Masse-Anschluss bei QT310 bezieht sich ausschließlich auf die ISDS-Kommunikation.
Ground pin of QT310 referring to ISDS communication exclusively.