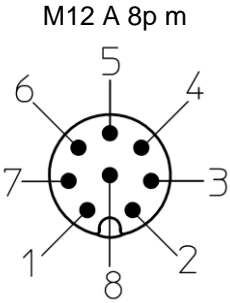
	HySense® CL 1xx 3402-CL1x-G926C0-000	
	<ul style="list-style-type: none"> • Hochintelligenter Füllstand-Sensor, Messgrößen: Füllstand, rel. Ölfeuchte, rel. Permittivität, Leitfähigkeit und Temperatur • 2 konfigurierbare Signalausgänge 4...20 mA • RS232/ CANopen Schnittstellen • Interner Speicher für 6000 Datensätze • G3/4'' Einschraubgewinde • Max. Betriebsdruck 50 bar 	<ul style="list-style-type: none"> • <i>High intelligent fluid level sensor, measured variable: fluid level, rel. oil humidity, rel. permittivity, conductivity and temperature</i> • <i>2 configurable Signal Outputs 4...20 mA</i> • <i>RS232/ CANopen Interfaces</i> • <i>Internal memory for 6000 data records</i> • <i>G3/4'' screw thread</i> • <i>Max. operating pressure 725 psi</i>

Beschreibung <i>Description</i>	<p>Der Sensor erfasst die physikalischen Ölkenngößen sowie deren zeitliche Änderungen. Nach einer Anlernphase berechnet der Sensor den temperatur-kompensierten Wert bezogen auf 40 °C von der Permittivität und der Leitfähigkeit. Intelligente Algorithmen bewerten den Zustand und die Öllebensdauer. Plötzlich auftretende Ereignisse werden sofort erkannt und können als Alarm ausgegeben werden. Der Sensor bietet den optimalen Schutz gegen Maschinenausfälle und -stillstand. Wartungsintervalle können individuell angepasst werden.</p>	<p><i>The sensor detects the physical oil characteristics as well as their temporal change. After a learning phase, the sensor calculates the temperature-compensated value based at 104 °F on the viscosity and permittivity. Intelligent algorithms evaluate the oil condition and oil life. Events that occur suddenly are recognized immediately and can be output as an alarm. The sensor offers optimal protection against machine failures and downtimes. Maintenance intervals can be adjusted individually.</i></p>
---	---	--

Verwendungszweck <i>Designated use</i>	<p>Zur Überwachung des Ölzustands und die zeitliche Veränderung des Öls in stationären sowie mobilen Hydraulikanlagen. In Verwendung mit Hydraulikölen und sonstigen Ölen auf Mineralölbasis.</p>	<p><i>For monitoring the oil condition and temporal change of the oil in stationary and mobile hydraulic systems. In use with hydraulic oils and other mineral-based oils.</i></p>
--	---	--

Warnhinweise <i>Warning notices</i>	<p>Sensor darf nur in druckloser Anlage ausgetauscht werden!</p>	<p><i>Replace sensor in pressureless equipment only!</i></p>
---	--	--

Pinbelegungen <i>Pin assignments</i>		Rundsteckverbinder M12 x 1 mit Schraubverriegelung, A-Kodierung, 8-polig, Stecker <i>Circular connectors M12 x 1 with screw-locking, A-coding, 8 poles, male IEC / DIN EN 61076-2-101</i>			
		Bezeichnung <i>Labeling</i>	Nr. <i>No</i>	Funktion	Function
		V+	1	Stromversorgung	<i>Power supply</i>
		GND	2	Masse	<i>Ground</i>
		CAN L, TXD	3	CAN Low RS232-Signal TXD	<i>CAN Low RS232-signal TXD</i>
		CAN H, RXD	4	CAN High RS232-Signal RXD	<i>CAN High RS232-Signal RXD</i>
		Not Connected	5	Nicht verbunden	<i>Not connected</i>
		IOut1	6	4...20 mA	<i>4...20 mA out</i>
		IOut2	7	4...20 mA	<i>4...20 mA out</i>
		SGND	8	Signal Masse	<i>Signal Ground</i>

Can Open Parameter	MIN	Typisch <i>typically</i>	MAX	Einheit <i>Unit</i>
Übertragungsrate <i>Transfer rate</i>	50	250 (Default)	500	kbit/s
PDO <i>Process data object</i>	-	4	-	
Node-ID <i>Node-ID</i>	1	110	127	
Gerätestatus <i>Node state</i>	Pre-operational		Es kann mit dem Sensor kommuniziert werden, jedoch werden keine Werte gesendet. <i>It can be communicated with the sensor, but no values are sent.</i>	

Elektrische Eigenschaften <i>Electrical characteristics</i>	Referenzbedingungen / <i>Reference conditions</i> : Umgebungstemperatur Ta = 25°C / <i>environmental temperature Ta = 77 °F</i>			
	Parameter	MIN	MAX	Einheit <i>Units</i>
Spannungsversorgung <i>Power supply</i>	9	33	V	
Stromausgang <i>Power output</i>	4	20	mA	Ausgänge IOUT1 und IOUT2 sind frei konfigurierbar <i>IOUT1 and IOUT2 are freely configurable</i>
Stromaufnahme <i>Current consumption</i>	Max. 0.2		A	
Genauigkeit Stromausgang <i>Accuracy power output</i>	± 2		%	Bezogen auf den Messwert <i>In relation to the measured value</i>
Schnittstellen <i>Interfaces</i>	RS 232 / CANopen			SAEJ1937 auf Anfrage <i>SAEJ1937 on request</i>

Absolute Grenzwerte <i>Absolute maximum rating</i>				
Parameter	MIN	MAX	Einheit <i>Units</i>	Bemerkung <i>Remarks</i>
Rel. Permittivität <i>Rel. permittivity</i>	1	7	-	
Rel. Feuchtigkeit <i>Rel. humidity</i>	0	100	% r.H.	
Leitfähigkeit <i>Conductivity</i>	100	800 000	pS/m	
Füllstand <i>Fluid level</i>	115/288/515		mm	
Temperatur <i>Temperature</i>	-20 -4	+85 +185	°C °F	

Messgenauigkeit <i>Accuracy</i>				
Parameter	MIN	MAX	Einheit <i>Units</i>	Bemerkung <i>Remarks</i>
Rel. Permittivität <i>Rel. permittivity</i>	rel. ± 0.015		-	
Rel. Feuchtigkeit (10%...90%) <i>Rel. humidity (10% ... 90%)</i>	± 3		% r.H.	Kalibriert an Luft bei Raumtemperatur <i>Calibrated to air at room temperature</i>
Rel. Feuchtigkeit (<10%,>90%) <i>Rel. humidity (<10%,>90%)</i>	± 5		% r.H.	<i>temperature</i>
Leitfähigkeit (2000...800000 pS/m) <i>Conductivity (2000...800000 pS/m)</i>	Typ. <± 10		%	Bezogen auf den Messwert <i>In relation to the measured value</i>
Leitfähigkeit (100...2000 pS/m) <i>Conductivity (100...2000 pS/m)</i>	± 200		pS/m	
Temperatur <i>Temperature</i>	± 2		K	
Füllstand <i>Fluid Level</i>	Typ. <± 5		%	





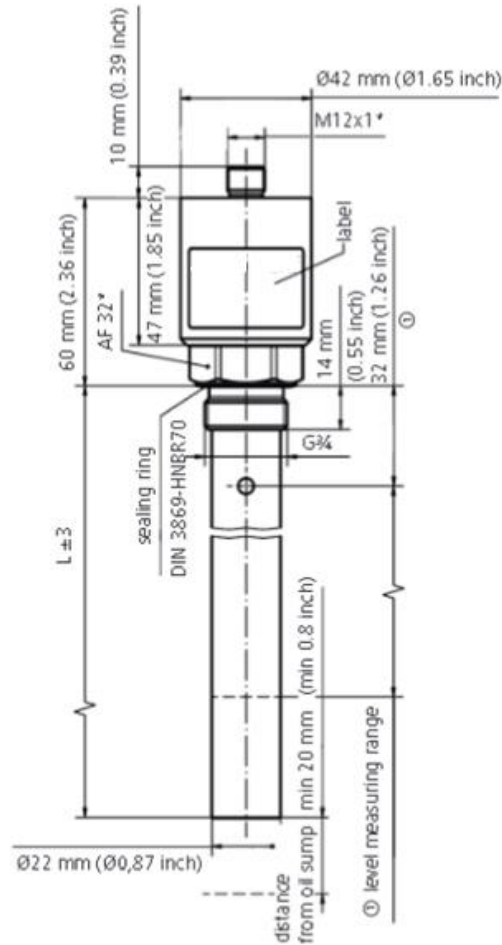

Messauflösung <i>Measuring resolution</i>				
Parameter	MIN	MAX	Einheit <i>Units</i>	Bemerkung <i>Remarks</i>
Rel. Permittivität <i>Rel. permittivity</i>	1*10 ⁻⁴		-	
Rel. Feuchtigkeit <i>Rel. humidity</i>	0.1		% r.H.	
Leitfähigkeit <i>Conductivity</i>	1		pS/m	

Temperatur <i>Temperature</i>	0.1	K	
Füllstand <i>Fluid level</i>	0.1	%	

Mechanische Eigenschaften <i>Mechanical characteristics</i>				
Parameter	Min	Max	Einheit <i>Units</i>	Bemerkung <i>Remarks</i>
Max. Betriebsdruck <i>Max. operating pressure</i>	-	50 725	bar psi	
Betriebstemperatur <i>Operating temperature</i>	-20 -4	+85 +185	°C °F	Außerhalb des Messbereiches sind keine plausiblen Messwerte zu erwarten <i>Outside the specified measuring range, there are no plausible measuring values to expected</i>
Kompatible Flüssigkeiten <i>Compatible fluids</i>	<ul style="list-style-type: none"> • Mineralöle • Synthetische Ester • Polyalkylenglykole • Zink- und aschefreie Öle • Polyalphaolefine 			<ul style="list-style-type: none"> • <i>Mineral oil</i> • <i>Sythetic esters</i> • <i>Polyalkylenglycos</i> • <i>Zinc- and ash free oils</i> • <i>Polyalphaolefins</i>
Benetzte Materialien <i>Wetted materials</i>	Aluminium, HNBR, Polyurethanharz, Epoxidharz, Chemisch Nickel/Gold, Lötzinn, Aluminiumoxid, Glas, Gold, Silber-Palladium			<i>Aluminium, HNBR, polyurethan resin, epoxy resin, chemical nickel/gold, soldering tin, aluminium oxid, glass, gold, silver-palladium</i>
Schutzklasse <i>Protection class</i>	IP 67			
Gewindeanschluss <i>Threaded connection</i>	G 3/4		Zoll	
Anzugsdrehmoment G 3/4 <i>Tightening torque</i>	45 ± 4.5		Nm	Sensor
Anzugsdrehmoment M12x1 <i>Tightening torque</i>	0.1		Nm	Stecker
Gewicht <i>Weight</i>	170 / 210 / 250		g	

Baugruppen-Zeichnung
Assembly drawing

Einbauhinweise
Installation instruction

- Sensor sollte nicht unmittelbar im Ölsumpf des Tanks verbaut werden
 - Idealerweise bei Tankeinbau in der Nähe von Rücklauf- bzw. Spüleleitung
 - Um einen thermischen Einfluss zu vermeiden, den Sensor nicht in der Nähe von heißen Bauteilen installieren
 - Zur Erzielung repräsentativer Messwerte platzieren Sie den Sensor an einer charakteristischen Stelle. Eine bevorzugte Strömungsrichtung gibt es nicht. Beachten Sie für den Einbau des Sensors dessen technische Daten.
- *The sensor should not directly be placed in the oil sump of the tank*
 - *Ideally the sensor should be placed in the vicinity of the return or flushing line*
 - *To avoid a thermal influence, the sensor should not be placed in the near of hot places*
 - *In order to obtain representative measured values, place the sensor at a characteristic location. There is no preferred flow direction. Observe the technical data for the installation of the sensor*

Typenschild <i>Type plate</i>	<div style="text-align: right; font-size: 2em; font-weight: bold;">HySense® CL1xx</div> <div style="text-align: right; font-size: 2em; font-weight: bold;">CE</div> <p>Füllstandssensor/ level sensor</p> <p style="text-align: right;">3402-CL1X-G926C0-000</p> <table style="width: 100%;"> <tr> <td>Pmax</td> <td>50 bar</td> <td rowspan="4" style="text-align: center; vertical-align: middle;">  (default) </td> <td rowspan="4" style="text-align: center; vertical-align: middle;">  </td> </tr> <tr> <td>SN</td> <td>000003</td> </tr> <tr> <td>Node ID</td> <td>110</td> </tr> <tr> <td>Baud Rate</td> <td>250kbit/s</td> </tr> </table> <div style="display: flex; justify-content: space-between; align-items: center; margin-top: 10px;">  <div style="font-weight: bold; font-size: 1.2em;">HYDROTECHNIK</div> <div style="font-size: 0.8em;">Limburg / Germany</div> </div>	Pmax	50 bar	 (default)		SN	000003	Node ID	110	Baud Rate	250kbit/s
Pmax	50 bar	 (default)									
SN	000003										
Node ID	110										
Baud Rate	250kbit/s										

TKZ / order number	Bestellnummer <i>Ordering Number</i>	Bemerkung / <i>Remarks</i>
HySense® CL120	3402-CL12-G926C0-000	Eintauchlänge 200 mm <i>Immersion length 200 mm</i>
HySense® CL130	3402-CL13-G926C0-000	Eintauchlänge 375 mm <i>Immersion length 375 mm</i>
HySense® CL160	3402-CL16-G926C0-000	Eintauchlänge 615 mm <i>Immersion length 615 mm</i>

TKZ / order number	Zubehör und Ersatzteile / Accessories and spare parts	
8812-00-00.36	Netzgerät M12 x 1; 8 pol. Buchse mit Länder-Steckeradapter <i>AC adapter M12 x 1; 8 pin female with country adapter</i>	Stromversorgung Power supply
8808-50-01.03	Y-Verteiler M12 8-polig; Buchse, Stecker, Buchse <i>Y-connector M12 8-pole; female, male, female</i>	Erforderlich um Stromversorgung und CAN/RS232 gleichzeitig zu nutzen <i>Required to use power supply and CAN/RS232 at the same time</i>
8824-T1-02.50	Messkabel M12 x 1; 8 pol. Buchse / offenes Ende; 2,5m <i>Connection cable M12 x 1; 8 pin female / open end; 2,5m</i>	CAN/RS232 Verbindungskabel mit offenen Litzen <i>CAN/RS232 connection cable with open cord</i>
8824-T6-02.50	Messkabel M12 x 1; 8 pol. Stecker / 8 pol. Buchse; 2,5m <i>Connection cable M12 x 1; 8 pin male / 8 pin female; 2,5m</i>	Einsatz mit MS 4010 / MS 4070 / MS 5060Plus / MS 5070 <i>Use with MS 4010 / MS 4070 / MS 5060Plus / MS 5070</i>

8824-T2-02.50	CAN Verbindungskabel MS 4010 / MS 4070 / MS 5060 plus / MS 5070; M12 x 1; Stecker 8 polig / Stecker 8 polig; 2,5m <i>CAN connection cable MS 4010 / MS 4070 / MS 5060 plus / MS 5070; M12 x 1; 8 pin male / 8 pin male; 2,5m</i>	Einsatz mit Y-Verteiler 8808-50-01.03 und Messgerät <i>Application with Y-connector 8808-50-01.03 and handheld</i>
8824-T7-01.00	Schnittstellenkabel M12 x 1; Stecker; 8-Pol / D-SUB-Buchse; 9 Pol; 1m <i>Interface cable M12 x 1; 8-pole male / 9 pin D-SUB female; 1m</i>	Einsatz mit Y-Verteiler 8808-50-01.03 und COM-Port <i>Application with Y-connector 8808-50-01.03 and COM-Port</i>

Haftungsausschluss / Limitation of Liability	Änderungen an Produkten und Dokumentationen im Sinne des technischen Fortschritts und der stetigen Verbesserung sind vorbehalten und können jederzeit ohne vorherige Mitteilung eintreten. Die dann gültigen Spezifikationen können von den Angaben in dieser Revision des technischen Datenblatts abweichen. Druckfehler sind vorbehalten. Im Zweifelsfall gilt die deutsche Sprachversion.	<i>Changes of products and documentation in the sense of technical progress and continuous improvement may occur at any time without prior notification. Hence specifications may than differ from those given in this revision of the technical data sheet. There is no liability for possible misprints. The German language version is valid in any case of doubt.</i>
---	--	---

Europäische Konformität European Conformity		
Elektromagnetische Verträglichkeit / <i>Electromagnetic compatibility</i>	Richtlinie 2014/30/EU	<i>Directive 2014/30/EU</i>
Druckgeräte / <i>Pressure equipment</i>	Richtlinie 2014/68/EU	<i>Directive 2014/68/EU</i>
RoHS - <i>Restriction of Hazardous Substances</i>	Richtlinie 2011/65/EU	<i>Directive: 2011/65/EU</i>

Hinweise zur Entsorgung / Disposal information		
WEEE Elektro- und Elektronik-Altgeräte / <i>Waste electrical and electronic equipment</i>	Richtlinie 2012/19/EU	<i>Directive 2012/19/EU</i>
	Dieses Produkt darf nicht mit dem Hausmüll entsorgt werden. Ausführliche Hinweise zur Entsorgung finden Sie auf unserer Homepage www.hydrotechnik.com	<i>This product is not to be disposed of in the household waste. Further information for disposal can to be found on our website www.hydrotechnik.com</i>